

THERMACORE® DOOR SYSTEMS



PRODUCT LINE

MODELS

591/592/593/594/596/598/599/850



INDUSTRY LEADING
COMMERCIAL & INDUSTRIAL SOLUTIONS



General features and benefits

Constructed for superior performance

- Continuous foamed in place polyurethane insulation and roll-formed, hot-dipped galvanized steel construction provides superior thermal efficiency, exceptional strength-to-weight ratio and proven durability
- Dual thermal break and joint seal between internal and external skins minimize air infiltration and provides the highest door system thermal efficiency in the industry
- Specially designed track and heavy-duty fixtures ensure a tight and reliable fit
- Two coats of baked-on polyester paint provide a durable finish
- Unique design allows on-site door customization for quick and precise installation, replacement or repairs

High-usage components for special applications promotes long life and low maintenance

- Heavy-duty, precision ground headplate bearings for enhanced counterbalance performance
- Oil-tempered, heavy-duty helical wound, torsion springs, available in up to 100,000 cycles for extra long life

- Solid steel counterbalance shaft reduces fatigue and deflection
- Double end stiles and end hinges lessen loads on door-section
- Heavy-duty 3" (76 mm) hot-dipped galvanized steel track and 10 ball-bearing, long-stem rollers
- Additional center hinges reduce overall door section hinge loads
- Bottom sensing edge stops/reverses door upon contact with an obstruction

Built to last

- 10-year* limited warranty against panel delamination of foam and steel skins
- 1-year limited warranty on door
- 3-year/20,000 cycle limited warranty on door and operator system

*8-year warranty on model 598

Cover image:

Model 592, Ribbed panel, White paint, finish 25"x12" Aluminum Sash Section lites

Image above:

Model 591, Ribbed panel, Gray paint finish, 25"x12" oval lites



SECTION PROFILES

Model 850

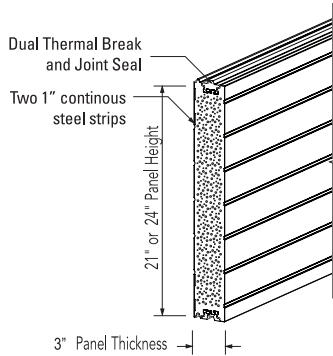

Model 596

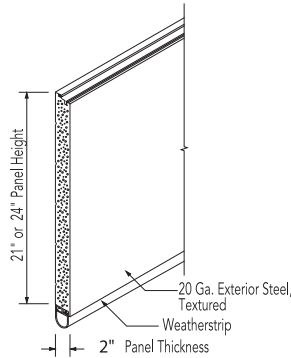

Models 591 / 592 / 599*

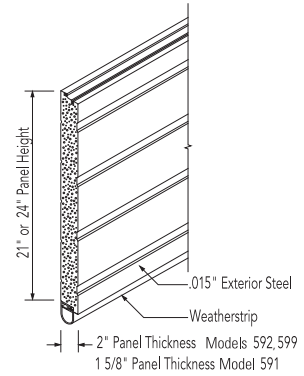

Model 593

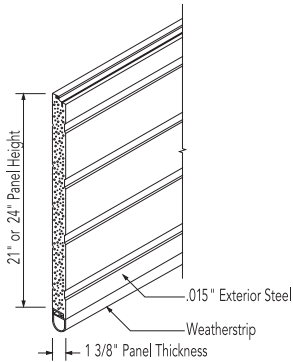

Model 594

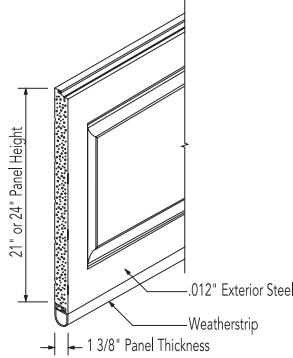

Model 598

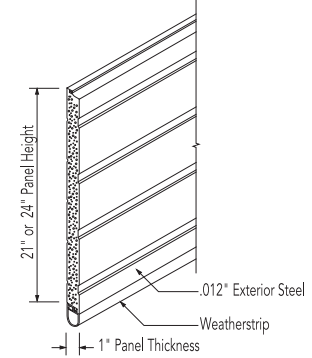

JOINT PROFILES

Model 850

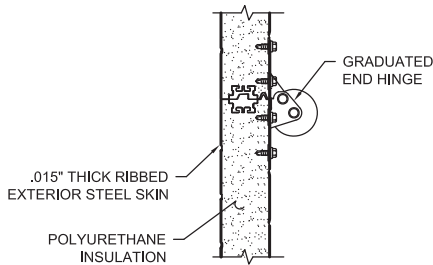

Models 596 / 599

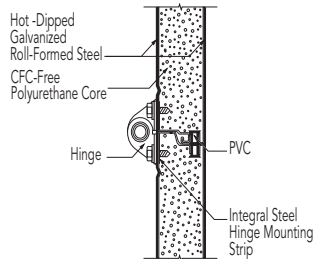

Models 591 / 592

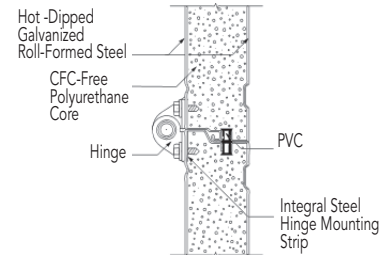

Models 593 / 594

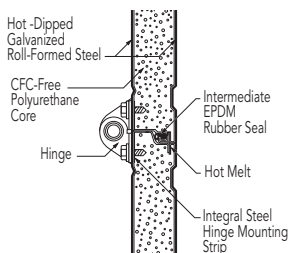

Model 598

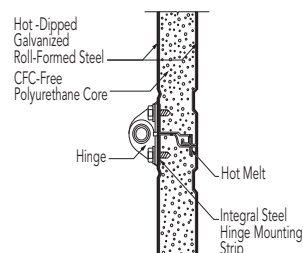

Panel and glazing options for models 591 / 592 / 593 / 598

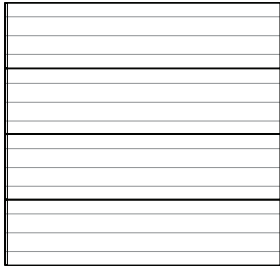

Ribbed panel



Double Thermal Acrylic
(25" w by 12" h)



Aluminum Sash Section
with DSB glazing*



Insulated DSB
(24" w by 7" h)



Clear Long** (44" w by 15" h)

* Not available on Model 598

**Not available on doors wider than 20'2". Not available on Model 591.

Panel and glazing options for model 594

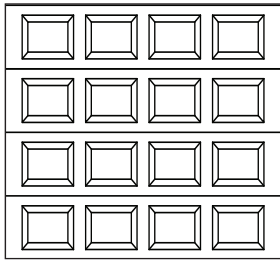

Raised panel



Insulated DSB
(20.75" w by 15" h)



Aluminum Sash Section
with DSB glazing

Panel and glazing options for models 596 / 599

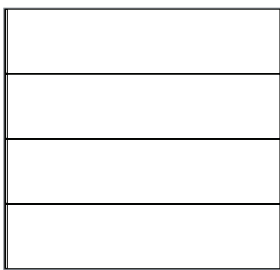

Flush panel



Double Thermal Acrylic
(25" w by 12" h)



Aluminum Sash Section
with DSB glazing



Insulated DSB
(24" w by 7" h)



Clear Long* (44" w by 15" h)

*Not available on doors wider than 20'2".

Panel and glazing options for model 850



Microgroove, texture



Large Lites (25" w by 13" h)*



Insulated (24" w by 6" h)

Both lites available with insulated glass, insulated tempered glass or multi-wall polycarbonate clear glazing (brown, white or clear). Black frame is standard.

*Color matched frames are available.

Contact your local Overhead Door™ Distributor or visit our Architects Corner at www.overheaddoor.com/architects-corner for specific glazing detail.



General specifications for THERMACORE® DOOR SYSTEMS

	Advanced Performance	Extra heavy duty	Heavy duty			Medium duty		Light duty
Model	850	596	599	592	591	593	594	598
Nominal thickness	3" (76.2 mm)	2" (51 mm)	2" (51 mm)	2" (51 mm)	1 5/8" (51 mm)	1 3/8" (51 mm)	1 3/8" (51 mm)	1" (25 mm)
R-value ¹ (K m ² /W)	26 (4.58)	17.40 (3.06)	17.50 (3.09)	17.50 (3.09)	14.86 (2.63)	12.76 (2.26)	12.76 (2.26)	9.31 (1.64)
U-value ² (W/K m ²)	.038 (.220)	.057 (.327)	.057 (.327)	.057 (.327)	.067 (.380)	.078 (.443)	.078 (.443)	.107 (.608)
Air infiltration at 25 mph (at 40 kmp/h)	.21 cfm/ft ² (3.83 m ³ /hr/m ²)	.13 cfm/ft ² (2.37 m ³ /hr/m ²)	.13 cfm/ft ² (2.37 m ³ /hr/m ²)	.13 cfm/ft ² (2.37 m ³ /hr/m ²)	.08 cfm/ft ² (1.46 m ³ /hr/m ²)	.15 cfm/ft ² (2.74 m ³ /hr/m ²)	.15 cfm/ft ² (2.74 m ³ /hr/m ²)	.46 cfm/ft ² (8.40 m ³ /hr/m ²)
Thermal break	Dual thermal brake & joint seal	PVC	PVC	PVC	PVC	Hot melt	Hot melt	Hot melt
STC ⁴ rating	class 22	class 26	N/A	class 26	N/A	N/A	N/A	N/A
Exterior steel gauge	.015" (.38 mm)	20-ga galvanized (.91 mm)	.015" (.38 mm)	.015" (.38 mm)	.015" (.38 mm)	.015" (.38 mm)	.012" (.30 mm)	.012" (.30 mm)
Exterior surface	microgroove, texture	flush	flush	ribbed	ribbed	ribbed	raised panel	ribbed
Standard end stiles	18-gauge	16-gauge	16-gauge	16-gauge	16-gauge	20-gauge	20-gauge	20-gauge
Standard max. width ³	40'2" (12,243 mm)	36'2" (11,024 mm)	40'2" (12,243 mm)	40'2" (12,243 mm)	35'2" (10,719 mm)	20'2" (6,147 mm)	20'2" (6,147 mm)	16'2" (4,928 mm)
Standard max. height ³	24'1" (7,341 mm)	24'1" (7,341 mm)	32'1" (9,779 mm)	32'1" (9,779 mm)	24'1" (7,341 mm)	16'1" (4,902 mm)	16'1" (4,902 mm)	14'1" (4,293 mm)
Exterior color	White, Tan, Almond, Industrial Brown	White, Tan, Gray, Industrial Brown	White	White, Tan, Gray, Industrial Brown	White, Tan, Gray, Industrial Brown	White, Tan, Gray, Industrial Brown	White, Almond, Sandstone, Hunter Green, Chestnut Brown, Terra Bronze, Desert Tan	White
Optional colors				Trinar White Trinar Brown Trinar Beige	Trinar White Trinar Brown Trinar Beige	Trinar White Trinar Brown Trinar Beige	Trinar White Trinar Brown Trinar Beige	

Available options for THERMACORE® DOOR SYSTEMS

Electric operator	•	•	•	•	•	•	•	•
Chain hoist	•	•	•	•	•	•	•	•
Thermal glazing	•	•	•	•	•	•	•	•
Four-section pass door		•	•	•	•			
High-usage components	•	•	•	•	•	•	•	
Posi-tension drums		•	•	•	•	•	•	•
Safety bottom fixture	•	•	•	•	•	•	•	
Bottom sensing edge	•	•	•	•	•	•	•	•
EPDM ⁵ rubber header seal		•	•	•	•	•	•	•
Aluminum full view sash section		•	•	•	•	•	•	
Tumbler keyed lock		•	•	•	•	•	•	•
Exhaust ports	•	•	•	•	•	•	•	•

¹ Overhead Door Corporation uses a calculated door section R-value for our insulated doors.

² U-value is a measure of the flow of heat through an insulating or building material; the lower the U-value, the better the insulating ability. U-value is the inverse of R-value.

³ Maximum door size is dependent on weight. Doors are not available to the maximum height at the maximum width.

⁴ Sound Transmission Class (STC): how well the door reduces airborne sound. The higher the number the better sound reduction.

⁵ Ethylene propylene diene monomer rubber. Used in the automotive industry for its superior durability and wearability.



MODEL 850

For applications where climate control, durability and ease of maintenance are primary concerns



Standard features at a glance

Panel thickness	3" (76.2 mm)
Standard maximum width ⁵	40'2" (12,253 mm)
Standard maximum height ⁵	24'1" (7,341 mm)
Exterior steel gauge	.015" (.38 mm)
Exterior surface	Microgroove, textured
R-value ¹	26 (4.58 K m ² /W)
U-value ²	.038 (.22 W/K m ²)
Installed U-factor ³	.14 Btu/hr * ft ² * F° (.80 W/m ²)
STC rating ⁴	Class 22
Air infiltration: at 25 mph (40 kmph)	.21 cfm/ft ² (5.95 m ³ /hr/m ²)
IECC®	Meets requirements for U-factor and air infiltration
Thermal break	1-3/4" wide PVC thermal break; PVC thermal break on end stiles
Standard springs	10,000 cycle
Joint profile	Dual barrier tongue-in-groove meeting rail consists of the industry's first dual tongue and groove joint profile (patents pending)
Perimeter protection	Header seal Bottom weather seal; rigid PVC retainer with dual-durometer PVC bulb seal Enhanced thermal performance jamb seal (option) EPDM outer bulb seal recommended for more extreme environments (option)
Continuous hinge strip	Two continuous steel strips at top and bottom of section for hinge attachment
Exterior color	White, Brown, Almond, Taupe
Interior color	White
Limited warranty	10-year delamination 1-year material and workmanship 3-year/20,000 cycle door and operator system (material and workmanship)

Exterior color options



Options

- Large thermal lites (25" w x 13" h); black frame standard; optional color matched frame available
- Glass: insulated tempered, multi-wall polycarbonate in clear, bronze, or white
- High-cycle springs
- High-usage components
- Electric operator
- Chain hoist
- Cable failure device
- Exhaust ports

¹ R-value is a measure of thermal efficiency. The higher the R-value the greater the insulating properties of the door. Overhead Door Corporation uses a calculated door curtain R-value for our insulated doors.

² U-value is a measure of the flow of heat through an insulating or building material; the lower the U-value, the better the insulating ability. U-value is the inverse of R-value.

³ A tested value of actual energy loss - whether heat or cold-of an installed door, wall, or window assembly. The lower the number the lower the energy loss and therefore the better the thermal performance. For best U-factor, choose finish and color with high solar reflectance (bright colors).

⁴ Sound Transmission Class (STC): how well the door reduces airborne sound. The higher the number the better sound reduction.

⁵ Maximum door size is dependent on weight. Doors are not available to the maximum height at the maximum width.

For drawings and specifications please visit our website, www.overhaddoor.com/architects-corner.



MODELS 596

For extra-heavy-duty applications where thermal efficiency and sound suppression are desirable



Exterior color options



Standard features at a glance

Panel thickness	2" (51 mm)
Standard maximum width ⁴	36'2" (11,024 mm)
Standard maximum height ⁴	24'1" (7,341 mm)
Exterior steel gauge	20-gauge galvanized
Exterior surface	Flush, textured
R-value ¹	17.40 (3.06 K m ² /W)
U-value ²	.057 (.327 W/K m ²)
STC Rating ³	Class 26
Thermal break	PVC
Air infiltration: at 25 mph (40 kmph)	.13 cfm/ft ² (2.37 m ³ /hr/m ²)
IECC [®]	Meets requirements for U-factor and air infiltration
Standard springs	10,000 cycle
Exterior color	White, Gray, Industrial Brown, Tan
Interior color	White
Limited warranty	10-year delamination 1-year door 3-year/20,000 cycle door and operator system

Options

- Thermal glazing
- Aluminum sash section available to 24'2" (7,366 mm) wide
- Four-section pass door
- High-usage components
- Wind load options
- Electric operator
- Chain hoist
- Posi-Tension[®] drums
- Safety bottom fixtures
- Bottom-sensing edge
- Flexible jamb, header seal
- Exhaust ports

¹ R-value is a measure of thermal efficiency. The higher the R-value the greater the insulating properties of the door. Overhead Door Corporation uses a calculated door curtain R-value for our insulated doors.
² U-value is a measure of the flow of heat through an insulating or building material; the lower the U-value, the better the insulating ability. U-value is the inverse of R-value.
³ Sound Transmission Class (STC): how well the door reduces airborne sound. The higher the number the better sound reduction.
⁴ Maximum door size is dependent on weight. Doors are not available to the maximum height at the maximum width.

For drawings and specifications please visit our website, www.overheaddoor.com/architects-corner.



MODELS 592/599

For applications that demand high level of thermal efficiency and wind resistance



Exterior color options for Model 592



White Industrial Brown Gray Tan

Optional: Trinar White, Trinar Beige and Trinar Brown

Exterior color options for Model 599



White

Standard features at a glance

Panel thickness	2" (51 mm)
Standard maximum width ³	40'2" (12,243 mm)
Standard maximum height ³	32'1" (9,779 mm)
Exterior steel	.015" (.38 mm) galv.
Exterior surface	Model 592–Ribbed, textured Model 599–Flush, textured
R-value ¹	17.50 (3.09 K m ² /W)
U-value ²	.057 (.324 W/K m ²)
Air infiltration: at 25 mph (40 kmph)	.13 cfm/ft ² (2.37 m ³ /hr/m ²)
IECC®	Meets requirements for U-factor and air infiltration
Thermal break	PVC
Standard springs	10,000 cycle
Exterior color	Model 592: White, Tan, Gray, Industrial Brown, plus optional Trinar colors: White, Brown and Beige Model 599: White only
Interior color	White
Limited warranty	10-year delamination 1-year door 3-year/20,000 cycle door and operator system

Options

- Thermal glazing
- Aluminum sash section available to 24'2" (7,366 mm) wide
- High-usage components
- Wind load options
- Four-section pass door
- Chain hoist
- Posi-Tension® drums
- Safety bottom fixtures
- Bottom-sensing edge
- Flexible jamb, header seal
- Exhaust ports
- Electric operator

¹ R-value is a measure of thermal efficiency. The higher the R-value the greater the insulating properties of the door. Overhead Door Corporation uses a calculated door section R-value for our insulated doors.

² U-value is a measure of the flow of heat through an insulating or building material; the lower the U-value, the better the insulating ability. U-value is the inverse of R-value.

³ Maximum door size is dependent on weight. Doors are not available to the maximum height at the maximum width.

For drawings and specifications please visit our website, www.overhaddoor.com/architects-corner.



MODEL 591

For heavy-duty applications that require high thermal efficiency and durability



Exterior color options



White Industrial Brown Gray Tan

Optional: Trinar White, Trinar Beige and Trinar Brown

Standard features at a glance

Panel thickness	1 5/8" (41 mm)
Standard maximum width ³	35'2" (10,719 mm)
Standard maximum height ³	24'1" (7,341 mm)
Exterior steel	.015" (.38 mm) galvanized
Exterior surface	Ribbed, textured
R-value ¹	14.86 (2.63 K m ² /W)
U-value ²	.067 (.380 W/K m ²)
Thermal break	PVC
Air infiltration: at 25 mph (40 kmph)	.08 cfm/ft ² (1.46 m ³ /hr/m ²)
IECC®	Meets requirements for U-factor and air infiltration
Standard springs	10,000 cycle
Exterior color	White, Tan, Gray, Industrial Brown plus optional Trinar colors: White, Brown and Beige
Interior color	White
Limited warranty	10-year delamination 1-year door 3-year/20,000 cycle door and operator system

Options

Thermal glazing
Aluminum sash section available to 24'2" (7,366 mm) wide
Four-section pass door
High-usage components
Wind load options
Electric operator
Chain hoist
Posi-Tension® drums
Safety bottom fixtures
Bottom-sensing edge
Flexible jamb, header seal
Exhaust ports

¹ R-value is a measure of thermal efficiency. The higher the R-value the greater the insulating properties of the door. Overhead Door Corporation uses a calculated door section R-value for our insulated doors.
² U-value is a measure of the flow of heat through an insulating or building material; the lower the U-value, the better the insulating ability. U-value is the inverse of R-value.
³ Maximum door size is dependent on weight. Doors are not available to the maximum height at the maximum width.

For drawings and specifications please visit our website, www.overhaddoor.com/architects-corner.



MODELS 593/594

Offers excellent thermal efficiency to fit a broad range of medium-duty applications



Exterior color options for Model 593



White Industrial Brown Gray Tan

Optional: Trinar White, Trinar Beige and Trinar Brown

Exterior color options for Model 594

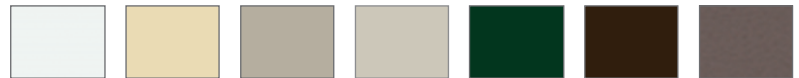

White Almond Sandstone Desert Tan Hunter Green Brown Terra Bronze

Optional: Trinar White, Trinar Beige and Trinar Brown

Standard features at a glance

Panel thickness	1 3/8" (35 mm)
Standard maximum width ³	20'2" (6,147 mm) 16'1" (4,902 mm)
Standard maximum height ³	24'1" (7,341 mm)
Exterior steel	Model 593: .015" (.38 mm) galv. Model 594: .012" (.3 mm) galv.
Exterior surface	Model 593—Ribbed, textured Model 594—Raised-panel, textured
R-value ¹	12.76 (2.26 K m ² /W)
U-value ²	.078 (.443 W/K m ²)
Air infiltration: at 25 mph (40 kmph)	.15 cfm/ft ² (2.7 m ³ /hr/m ²)
IECC®	Meets requirements for U-factor
Thermal break	Hot melt
Standard springs	10,000 cycle
Interior color	White
Limited warranty	10-year delamination 1-year door 3-year/20,000 cycle door and operator system

Options

- Thermal glazing
- Aluminum sash section available
- High-usage components*
- Wind load options
- Chain hoist
- Posi-Tension® drums
- Safety bottom fixtures
- Bottom-sensing edge
- Flexible jamb, header seal
- Exhaust ports

¹ R-value is a measure of thermal efficiency. The higher the R-value the greater the insulating properties of the door. Overhead Door Corporation uses a calculated door section R-value for our insulated doors.

² U-value is a measure of the flow of heat through an insulating or building material; the lower the U-value, the better the insulating ability. U-value is the inverse of R-value.

³ Maximum door size is dependent on weight. Doors are not available to the maximum height at the maximum width.

For drawings and specifications please visit our website, www.overheaddoor.com/architects-corner.



MODEL 598

An economical choice for lighter-duty applications where thermal protection is important



Exterior color options



White

Standard features at a glance

Panel thickness	1" (25.4 mm)
Standard maximum width ³	16'2" (4,928 mm)
Standard maximum height ³	14'1" (4,293 mm)
Exterior steel	.012" (.3 mm) galvanized
Exterior surface	Ribbed, textured
R-value ¹	9.31 (1.64 K m ² /W)
U-value ²	.107 (.608 W/K m ²)
Air infiltration: at 25 mph (40 kmph)	.15 cfm/ft ² (2.7 m ³ /hr/m ²)
Thermal break	Hot melt
Standard springs	10,000 cycle
Exterior color	White
Interior color	White
Limited warranty	8-year delamination 1-year door 3-year/20,000 cycle door and operator system

Options

Thermal glazing
High cycle springs
Wind load options
Electric operator
Chain hoist
Posi-Tension® drums
Safety bottom fixture
Flexible jamb, header seal

¹ R-value is a measure of thermal efficiency. The higher the R-value the greater the insulating properties of the door. Overhead Door Corporation uses a calculated door section R-value for our insulated doors.
² U-value is a measure of the flow of heat through an insulating or building material; the lower the U-value, the better the insulating ability. U-value is the inverse of R-value.
³ Maximum door size is dependent on weight. Doors are not available to the maximum height at the maximum width.

For drawings and specifications please visit our website, www.overheaddoor.com/architects-corner.

Track detail

Any of the following track configurations can be selected for all Thermacore® models.

O.H.=Opening height L.C.=Lift clearance D.H.=Door height

Standard lift track Lift clearance track Standard Full vertical track

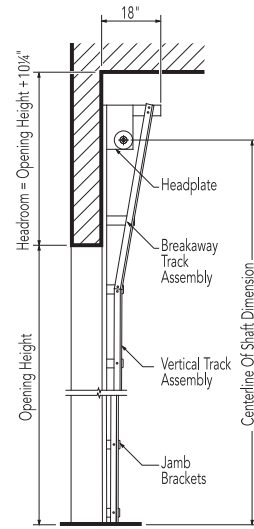
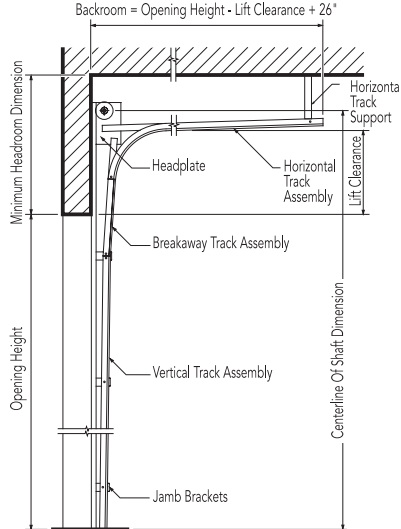
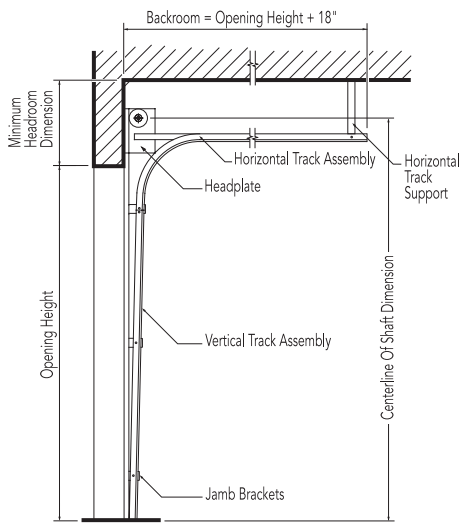

2" (51 mm) Track [15" (381 mm) radius]

Door height	Centerline of shaft	Minimum headroom
Thru 12'0" (3,658 mm)	O.H. + 11 5/8" (295 mm)	14 1/4" (362 mm)
Thru 16'0" (4,877 mm)	O.H. + 12 5/8" (321 mm)	20 1/2" (521 mm)

3" (76 mm) Track [15" (381 mm) radius] Single shaft

Thru 18'0" (5,486 mm)	O.H. + 14 5/8" (372 mm)	18" (457 mm)
Thru 32'0" (9,754 mm)	O.H. + 16 7/8" (429 mm)	21 1/2" (546 mm)

2" (51 mm) Track [15" (381 mm) radius]

Door height	Centerline of shaft	Minimum headroom
Thru 12'0" (3,658 mm)	O.H. + L.C. + 5 5/8" (143 mm)	L.C. + 8 3/4" (222 mm)
Thru 16'0" (4,877 mm)	O.H. + L.C. + 5 5/8" (143 mm)	L.C. + 11 1/4" (286 mm)

3" (76 mm) Track [15" (381 mm) radius] Single shaft

Thru 22'0" (6,706 mm)	O.H. + L.C. + 6 5/8" (168 mm)	L.C. + 11 1/2" (292 mm)
Thru 32'0" (9,754 mm)	O.H. + L.C. + 6 5/8" (168 mm)	L.C. + 12 1/4" (311 mm)

2" (51 mm) Track

Door height	Centerline of shaft	Minimum headroom
Thru 11'0" (3,353 mm)	O.H. + O.H. + 3/8" (10 mm)	O.H. + 10 1/4" (260 mm)
Thru 16'0" (4,877 mm)	O.H. + O.H. + 3/8" (10 mm)	O.H. + 10 1/4" (260 mm)

3" (76 mm) Track

Thru 18'0" (5,486 mm)	O.H. + O.H. + 3/8" (10 mm)	O.H. + 10 1/4" (260 mm)
-----------------------	----------------------------	-------------------------

Low headroom track Springs to front

Low headroom track Springs to rear

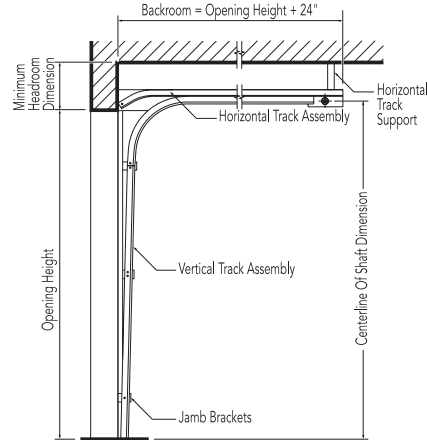
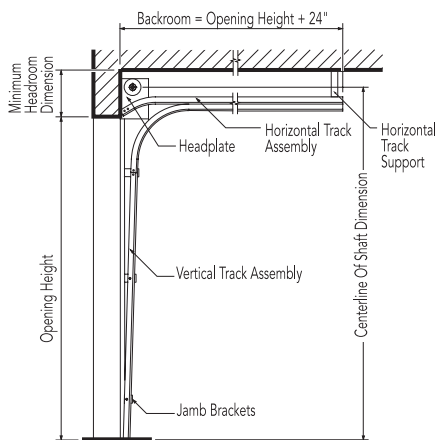

2" (51 mm) Track [15" (381 mm) radius]

Door height	Centerline of shaft	Minimum headroom
Thru 12'0" (3,658 mm)	D.H. + 8" (203 mm)	11 3/4" (299 mm)
Thru 16'0" (4,877 mm)	D.H. + 8" (203 mm)	12 1/2" (318 mm)

3" (76 mm) Track [15" (381 mm) radius]

Thru 12'0" (3,658 mm)	D.H. + 9" (229 mm)	13" (330 mm)
Thru 32'0" (5,486 mm)	D.H. + 9" (229 mm)	13 3/4" (349 mm)

2" (51 mm) Track [15" (381 mm) radius]

Door height	Centerline of shaft	Minimum headroom
Thru 12'0" (3,658 mm)	O.H. + 2" (51 mm)	7 1/2" (191 mm)
Thru 16'0" (4,866 mm)	O.H. 2" (51 mm)	8" (203 mm)

3" (76 mm) Track [15" (381 mm) radius]

Thru 18'0" (5,486 mm)	O.H. 6 3/4" (171 mm)	9 3/4" (248 mm)
-----------------------	----------------------	-----------------



Framing and pad detail

Framing and pad details for common installation of Thermacore® in steel, wood, concrete and masonry jambs are provided here. If you require additional information or have special project requirements, visit our Architects Corner at www.overhaddoor.com/architects-corner or consult with our Applications Engineering Group or your local Overhead Door™ distributor.

Steel jambs

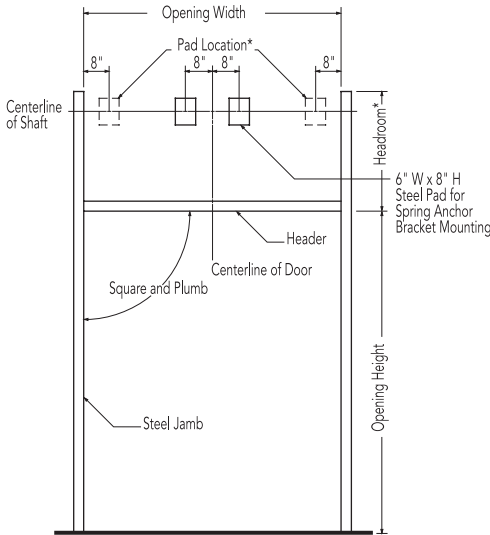

* Pad Location for additional shaft support brackets for doors over 18'3" wide

Wood jambs

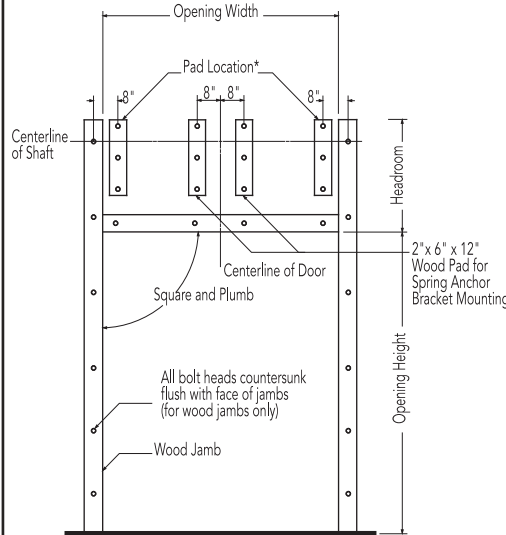

* Pad Location for additional shaft support brackets

Concrete/masonry jambs

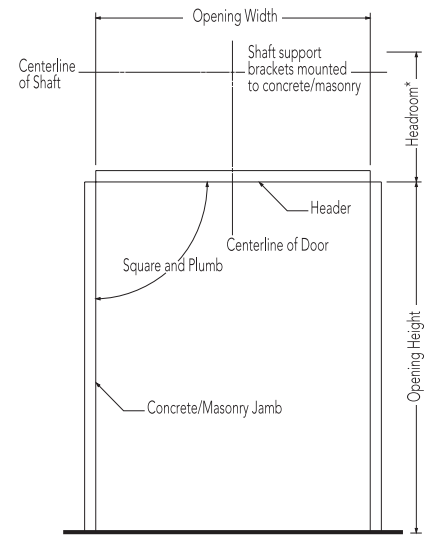

2" (51 mm) track

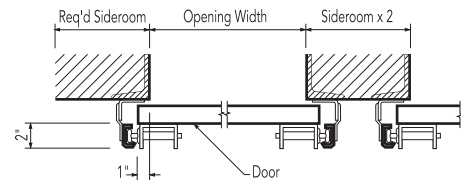

2" (51 mm) track

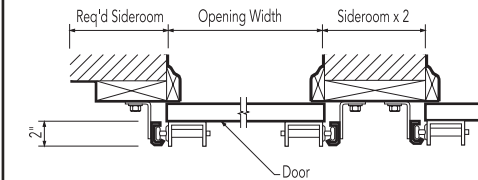

2" (51 mm) track

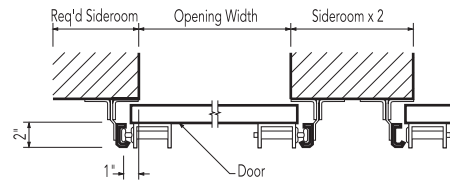

3" (76 mm) track

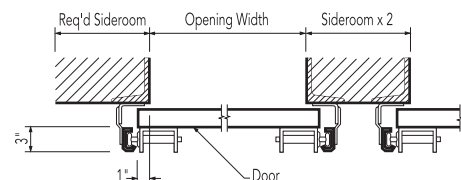

3" (76 mm) track

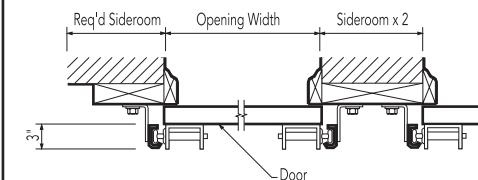

3" (76 mm) track

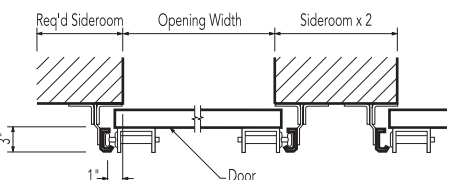

Minimum required sideroom

Track type	2" Track (51 mm)	3" Track (76 mm)
Standard lift	5" (127 mm)	7" (178 mm)
Low headroom	9" (229 mm)	10" (254 mm)
Lift clearance	5" (127 mm)	7" (178 mm)
Full vertical	5" (127 mm)	7" (178 mm)

Minimum required sideroom

Track type	2" Track (51 mm)	3" Track (76 mm)
Standard lift	5" (127 mm)	7" (178 mm)
Low headroom	8" (203 mm)	9" (229 mm)
Lift clearance	5" (127 mm)	7" (178 mm)
Full vertical	5" (127 mm)	7" (178 mm)

Minimum required sideroom

Track type	2" Track (51 mm)	3" Track (76 mm)
Standard lift	5" (127 mm)	7" (178 mm)
Low headroom	9" (229 mm)	10" (254 mm)
Lift clearance	5" (127 mm)	7" (178 mm)
Full vertical	5" (127 mm)	7" (178 mm)

Electric operators

We offer a broad line of electric operators to suit new construction and retrofit applications, as well as unusual or special requirements. In order to improve safety and enhance door and motor life, industry quality assurance guidelines recommend the choice of a single manufacturer for both door and operator applications.

We are one of the only national manufacturers to offer a full line of commercial and industrial doors and operators specifically designed for integral applications.

Model RHX®

Model RHX® is a heavy duty commercial operator designed to operate doors up to 24' (7,315 mm) in height and 3,696 pounds (1,676 kg). Available as either a trolley, sidemount or centermount.



Model RSX®

Model RSX® is a standard duty commercial operator designed to operate doors up to 24' (7,315 mm) in height and 1,620 pounds (735 kg). It offers unique features like LimitLock®, SuperBelt™ and 16 digit menu setup.



Model RMX®

Model RMX® is our most advanced medium-duty operator. It is designed for quicker installation and hassle-free operation and operates doors up to 14' (4,267 mm) in height and 620 pounds (282 kg). It is available as a trolley-type or side-mounted unit.



Operator control options

- Push-button, key or combination stations; surface-or flush-mounted for interior and/or exterior locations
- Vehicle detectors, key card reader, photocell and door timer controls
- Treadle or pull switch stations
- Wireless keypad entry and coded keyboard stations
- Universal programmable door timer
- Commercial light package
- Radio control systems (24 VAC or 120 VAC)
- Explosion and dust ignition-proof systems

Electric operator selection guide										
	Horsepower/ Newtons	Max. height of door	Max. weight of door	Super Belt™/ Polybelt	Worm gear	Adjustable clutch	Totally enclosed	Continuous duty	Explosion proof	Mounting type
RHX®	1/2 HP, 3/4 HP 1 HP, 3 HP	24'* (7,315 mm)	3,696 lbs (1,676 kg)		•	•		•	•	T, S, C
RSX®	1/2 HP, 3/4 HP 1 HP	24' (7,315 mm)	1620 (7,35 kg)	•		•	•	•		T, S, C
RMX®	1/2 HP	14' (4,267 mm)	620 (281 kg)	•						T, S

Mounting options:

T=Trolley S=Side mount C= Center mount

* RHX hoist operators may be used on doors taller than 24'. An optional extended limit kit may be required depending on the application.

Safety recommendations

We strongly recommend the use of a primary safety device as defined by UL325 2010. A primary safety device can be approved monitored photo-eyes or an approved monitored sensing edge. If a primary safety device is not installed, a constant contact control switch must be used to close the door. Contact your Overhead Door™ Distributor for more information.



Mounting details

Trolley-type (Drawbar) RMX®, RSX®, RHX®

Trolley-type (Drawbar) operators feature a power unit mounted between, above and to the rear of the horizontal tracks. The drawbar drive provides positive control of the door at all times, making this operator the preferred choice whenever possible. Maximum door width is 20' per drawbar. Door width over 20' requires dual drawbar installation. Available on Models RMX®, RSX® and RHX®.

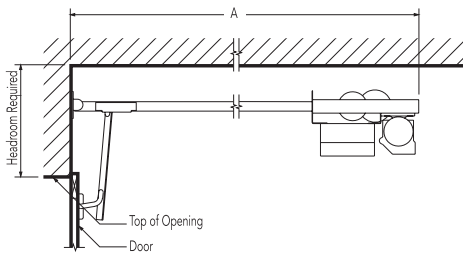

Side mount type (Jackshaft) RMX®, RSX®, RHX®

Side-mounted (Jackshaft) RMX®, RSX®, and RHX® operators feature a power unit mounted on the inside front wall and connected to the crosshead shaft, with an adjustable coupling or drive chain and sprockets.

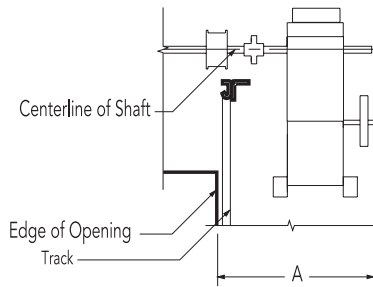

Center mount type/Jackshaft RSX®, RHX®

Center-mounted (Jackshaft) operators feature a power unit on the front wall above the door opening. No additional backroom is required. Available on models RSX® and RHX®.

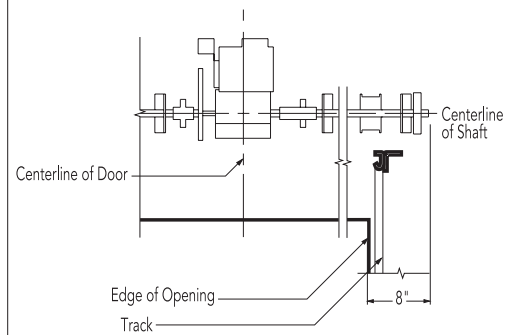

Minimum headroom requirements		"A" dimension - minimum (sideroom)		Minimum headroom requirements	
RMX®	Track requirements +4 1/2" (114 mm)	2" track (51 mm)	3" track (76 mm)	RSX®	Track requirements +14" (356 mm)
RSX®	Track requirements +5" (127 mm)	RMX®	18 1/2" (470 mm) 19 1/2" (495 mm)	RHX®	Track requirements +23 5/8" (600 mm)
RHX®	Track requirements +5" (127 mm)	RSX®	21" (533 mm) 22" (559 mm)		
		RHX®	21" (533 mm) 22" (559 mm)		

Depth requirements - "A" dimension (backroom)	
RMX®	Door height +4' 0" (1,219 mm)
RSX®	Door height +4' 0" (1,219 mm)
RHX®	Door height +4' 10" (1,473 mm)



Model 850, Flush panel



Tools to help you get the job done.

Architect's Corner

A resource for architects, containing comprehensive technical and resource materials to support your project, including drawings and specifications for commercial doors.

overheaddoor.com

The original, innovative choice for unequalled quality and service.

Overhead Door Corporation pioneered the garage door industry, inventing the first upward acting sectional door in 1921 and the first electric door operator in 1926. Today, we continue to be the industry leader through the strength of our product innovation, superior craftsmanship and outstanding customer support, underscoring a legacy of quality, expertise and integrity. That's why design and construction professionals specify Overhead Door™ products more often than any other brand. Our family of over 400 Overhead Door™ Distributors across the U.S. and Canada not only share our name and logo, but also our commitment to excellence.



INDUSTRY LEADING
COMMERCIAL & INDUSTRIAL SOLUTIONS

2501 S. State Hwy. 121 Bus., Suite 200, Lewisville, TX 75067
1-800-929-DOOR • sales@overheaddoor.com
overheaddoor.com